

Rotating Anode X-Ray Tube  
 Tubes Radiogènes à Anode Tournante  
 Röntgenröhre mit rotierender Anode  
 Tubos de Rayos-X con Ánodo Giratorio

Large - Black  
 Grand - Noir  
 Gross - Schwarz  
 Largo - Negro

Small -White  
 Petit - Blanc  
 Klein - Weiss  
 Pequeño - Blanco

Stand - By  
 Attente  
 Bereit Stehen  
 En Espera

Frame or Chasis  
 Masse  
 Chassis  
 Soporte o Chasis

X-Ray Tube  
 Tube Radiogène  
 Röntgenröhre  
 Tubo de Rayos X

Radiation Filter or Filtration  
 Filtre de rayonnement  
 Filterung  
 Filtración de Radiación

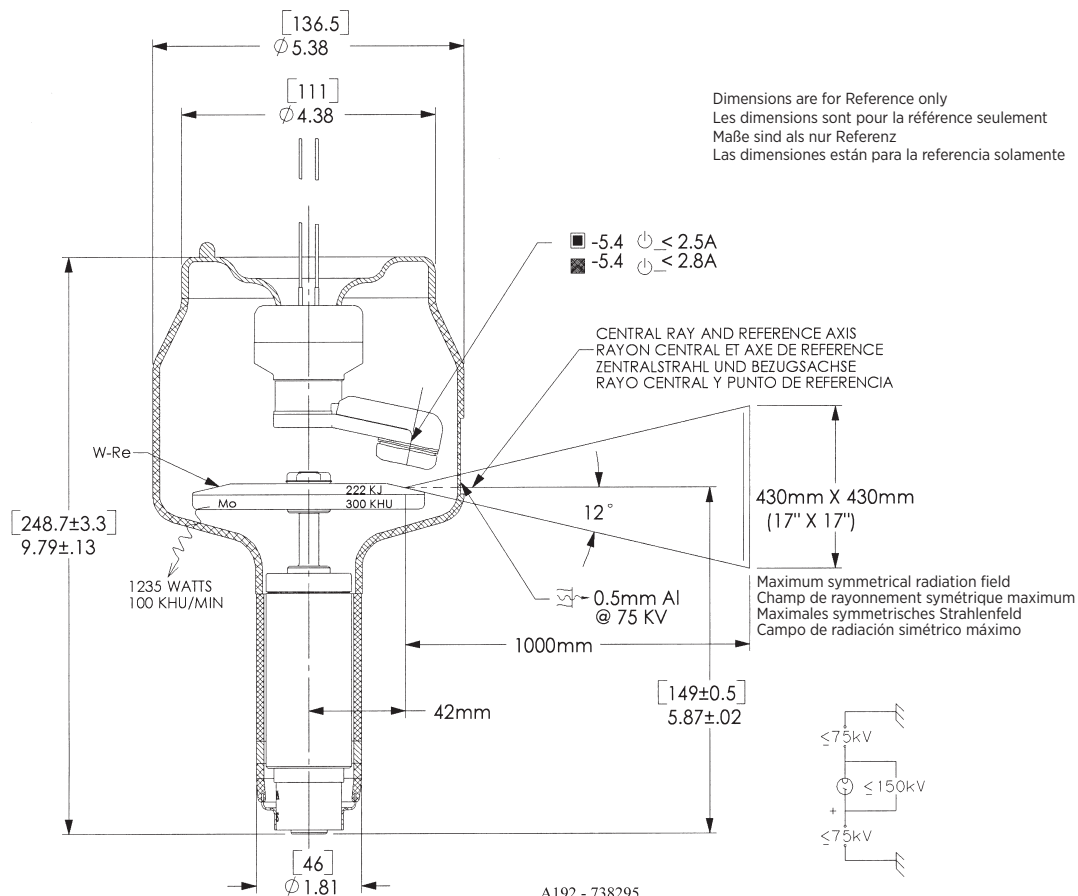

Note: Document originally drafted in the English language.

Product Description	Description du Produit	Produktbeschreibung	Descripcion del Producto
<p>The A-192 is a 4" (102 mm) 150 kV, 222 kJ (300 KHU) maximum anode heat content, rotating anode insert. This insert is specifically designed for heavy duty general radiographic and fluoro/spotfilm procedures. The insert features a 12° rhenium-tungsten molybdenum target and is available with the following nominal focal spot:</p> <p>0.6 - 1.2 IEC 60336</p> <p><b>Nominal Anode Input Power</b>                      Small - 40 kW IEC 60613                      Large - 100 kW IEC 60613                      For the equivalent anode input power of 125 Watts</p>	<p>Le tube A-192, à anode tournante de 102 mm, (4 pouces), 150 kV, avec une capacité calorifique maximale de 222 kJ (300 KUC) est à usage spécifique pour la radiographie de grande puissance et pour la radio-fluorographie. L'anode composite en Rhénium-Tungstène Molybdène avec pente d'anode de 12° est disponible avec les combinaisons focales suivantes:</p> <p>0,6 - 1,2 CEI 60336</p> <p><b>Puissance anodique nominale</b>                      Petit foyer - 40 kW CEI 60613                      Grand foyer - 100 kW CEI 60613                      Pour la puissance anodique d'équilibre thermique de 125 Watts</p>	<p>Die A-192 ist eine 4" (102 mm) Doppelfokus Drehanoden-Röntgenröhre, mit einer Anoden Wärmespeicherkapazität von 222 kJ (300 KHU) und einer max. Spannungsfestigkeit von 150 kV. Die Röhre wurde für stark frequentierte Aufnahmearbeitsplätze und für den Durchleuchtungs- und Zielgerätebetrieb (1mm FFA) ausgelegt. Der Rhenium, Wolfram, und Molybdän Anodenteller besitzt einen Winkel von 12°. Folgende Brennfleckkombination ist lieferbar:</p> <p>0.6 - 1.2 IEC 60336</p> <p><b>Nominale Anodenbezugsleistung</b>                      Klein - 40 kW IEC 60613                      Gross - 100 kW IEC 60613                      Gilt bei einer Aequivalent - Anodenleistung von 125 Watts</p>	<p>El A-192 es un tubo de ánodo giratorio de 102 mm, (4"), 150 kV, 222 kJ (300 KHU) diseñado específicamente para procedimientos generales de alto volumen en radiografía y fluoroscopia. Consta de un objetivo de renio, tungsteno y molibdeno con una pendiente de 12 grados. Disponible con las siguientes combinaciones de marcas focales:</p> <p>0.6 - 1.2 IEC 6033</p> <p><b>Potencia nominal de entrada del anodo</b>                      Foco fine - 40 kW IEC 60613                      Foco grueso - 100 kW IEC 60613                      Para una potencia equivalente del anodo de 125 Watts</p>

### 3 Ø Constant Potential

#### 50 Hz

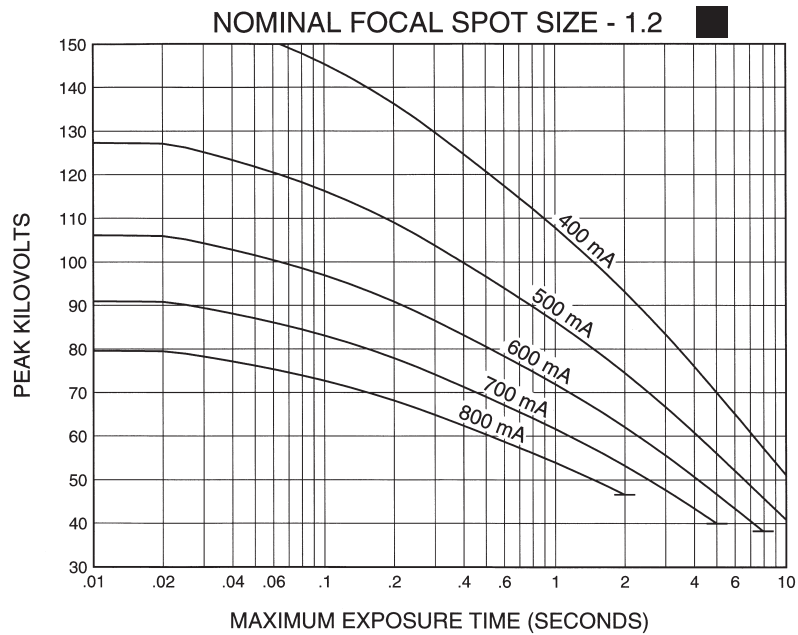
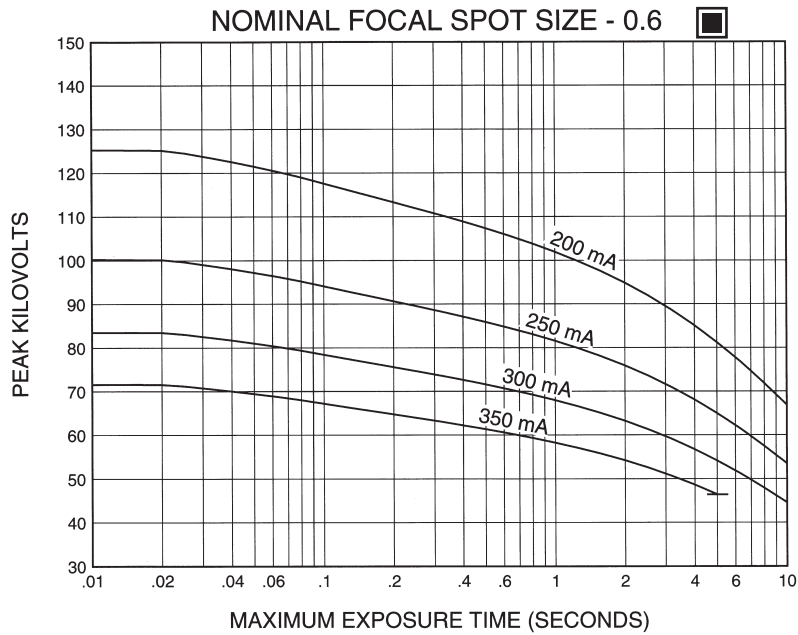

Nominal anode input power for the anode heat content 40%. IEC 60613

Puissance calorifique nominale de l'anode: 40%, CEI 60613

Thermische Anodenbezugsleistung bei einer Wärmespeicherung von 40%. IEC 60613

Aproximadamente el poder de penetracion para obtener un almacenaje de calor del anodo de 40%. IEC 60613

3 Ø Constant Potential 

**60 Hz**

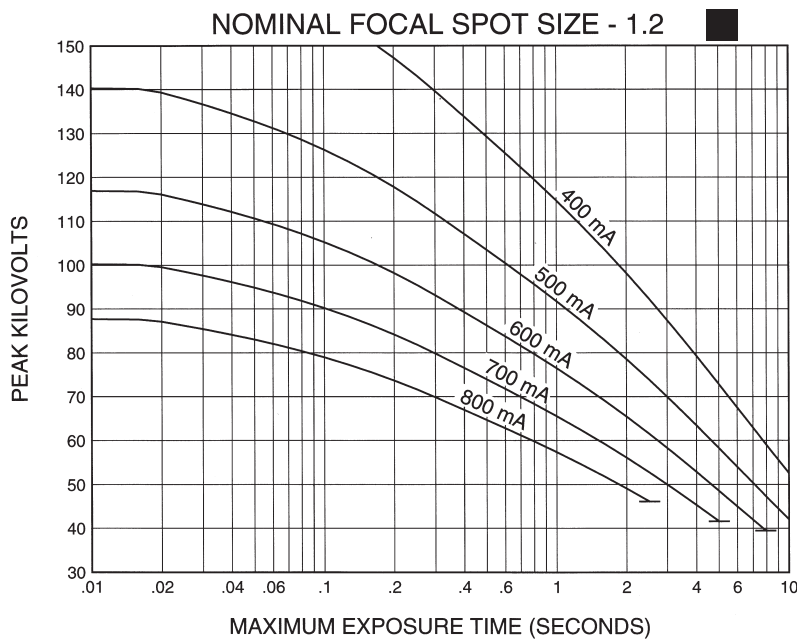
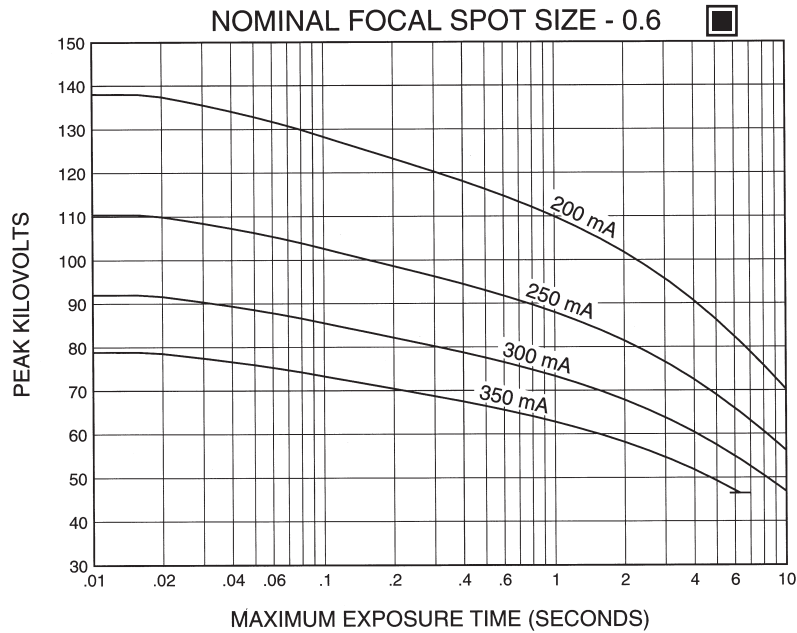

Nominal anode input power for the anode heat content 40%. IEC 60613

Puissance calorifique nominale de l'anode: 40%, CEI 60613

Thermische Anodenbezugsleistung bei einer Wärmespeicherung von 40%. IEC 60613

Aproximadamente el poder de penetración para obtener un almacenaje de calor del anodo de 40%. IEC 60613

3 Ø Constant Potential 

150 Hz

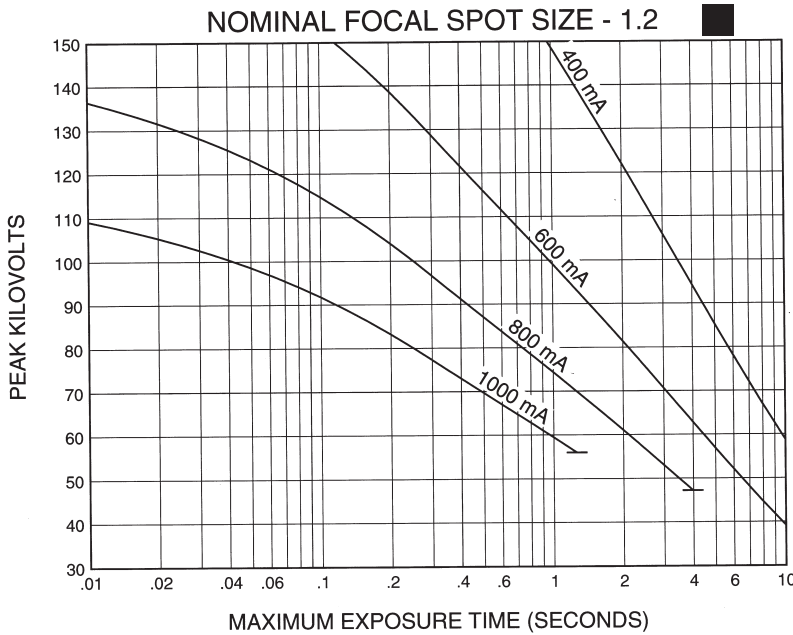
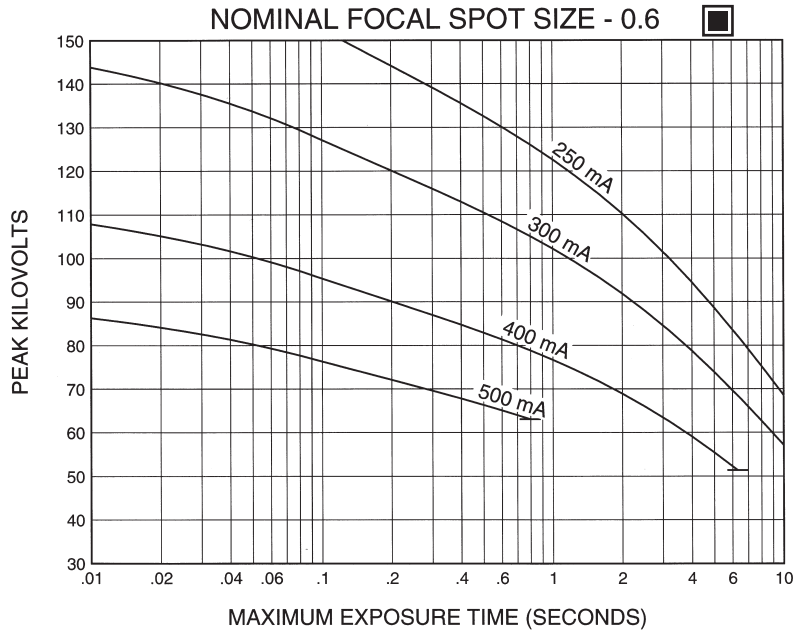

Nominal anode input power for the anode heat content 40%. IEC 60613

Puissance calorifique nominale de l'anode: 40%, CEI 60613

Thermische Anodenbezugsleistung bei einer Wärmespeicherung von 40%. IEC 60613

Aproximadamente el poder de penetración para obtener un almacenaje de calor del anodo de 40%. IEC 60613

3 Ø Constant Potential 

**180 Hz**

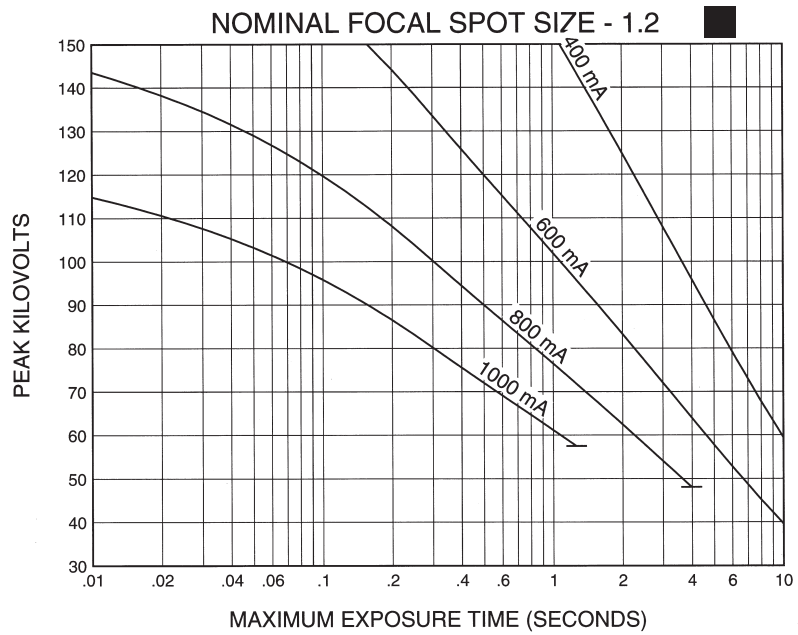
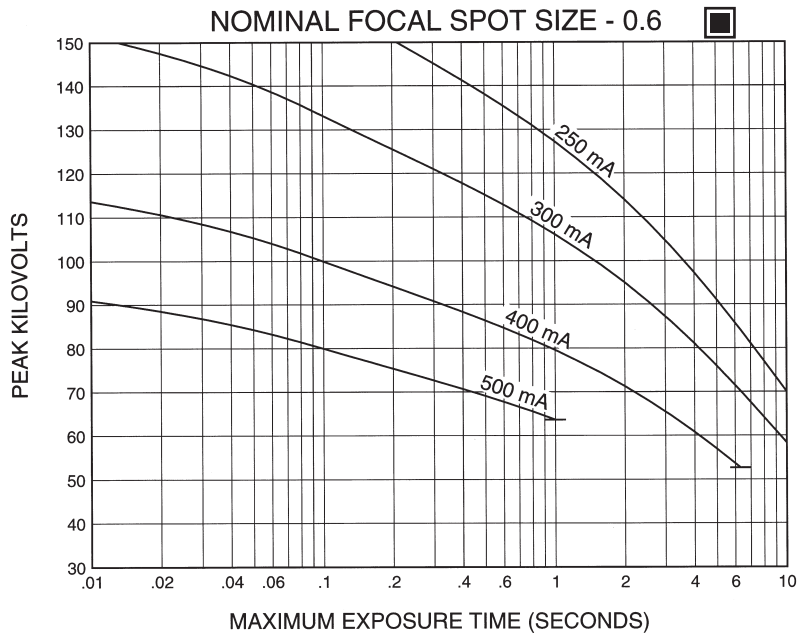

Nominal anode input power for the anode heat content 40%. IEC 60613

Puissance calorifique nominale de l'anode: 40%, CEI 60613

Thermische Anodenbezugsleistung bei einer Wärmespeicherung von 40%. IEC 60613

Aproximadamente el poder de penetración para obtener un almacenaje de calor del anodo de 40%. IEC 60613

## CINERADIOGRAPHIC RATINGS

### HOW TO USE CINERADIOGRAPHIC CHARTS

**General:** With the Cineradiographic rating chart we can determine the maximum allowable kW of the Cine pulse, or with a given kW determine maximum time in seconds the Cine run can progress.

The Most common way of using the charts is to determine maximum time of any expected Cine run and maximum duty factor. With a known duty factor and Cine run time kW can easily be determined.

**Definition of Terms**

**Time in seconds:** Total time of one Cine run, usually 5 to 12 seconds.

**Duty Factor in Percent (DF%):** Actual time during one second the x-ray tube is producing x-rays. If we select a 4 msec pulse width and 60 exposures per second the x-ray tube will be producing x-rays for a total of 240 msec each second or 24% of the time. The higher the DF number, the more load placed on the x-ray tube.

**Peak Pulse Power:** Peak energy in watts of any one Cine Pulse. Can be any combination of kV and mA allowed by Radiographic and Filament Emission curves.

Example:           80 kV at 400 mA equals  
  
                          80,000 V x 0.4 A = 32,000 W or 32 kW

**USING THE CINE RATING CHARTS:**

A-192 150/180 Hz 3 Phase 1.2 Focal Spot

**Example:** Determine maximum kW allowed with the following known factors:

- Maximum Pulse Width ..... 4 msec
- Exposures per Second ..... 60
- Maximum Cine Run Time ..... 10 seconds

**Calculate Duty Factor: (DF%)**

$$DF\% = \frac{\text{Pulse Width (mSec)} \times \text{Frames per Second}}{10}$$

$$DF\% = \frac{4 \text{ msec} \times 60 \text{ exp/sec}}{10} = \frac{240}{10} = 24\%$$

Refer to Rating Chart A-192 150/180 Hz  
3 Phase 1.2 Focal Spot:

At bottom of chart find 10 second line. Move vertically to intersection with 24% DF curve. Make a horizontal reference to left side of rating chart and note kW rating of 53 kW.

We now know each pulse during the cine run can have a maximum rating of 53 kW under conditions given in example.

kW = kV x mA. The kW of the exposure can be any combination of mA and kV allowed by the Radiographic and Filament Emission Charts.

The Cine rating charts are usable to 100% anode heat storage. The start of Cine run should be below 70% and heat storage. Exceeding 100% anode heat storage will cause anode track erosion with high risk of tube destruction.

### 3 Ø Constant Potential

#### 50/60 Hz

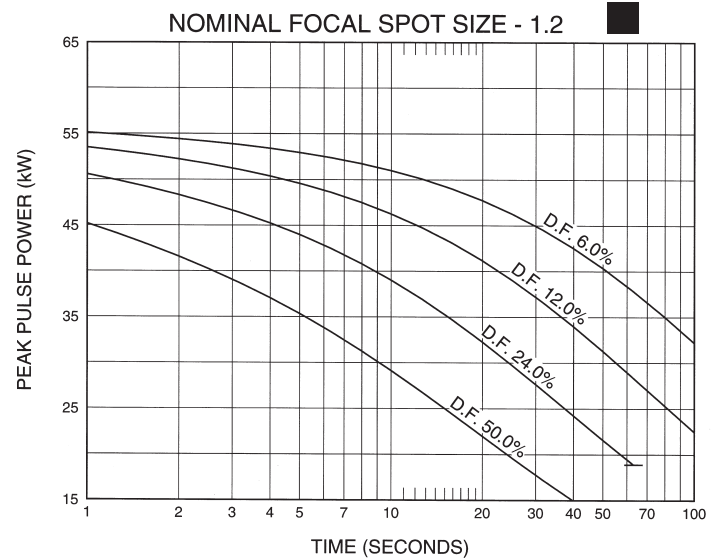
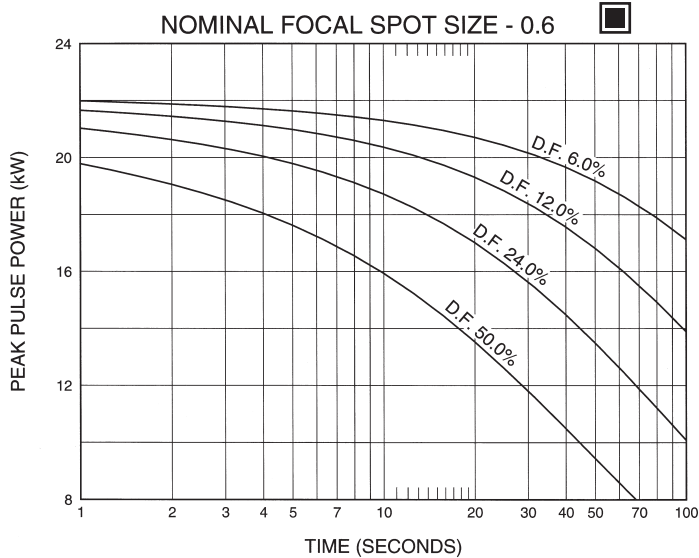

#### 150/180 Hz

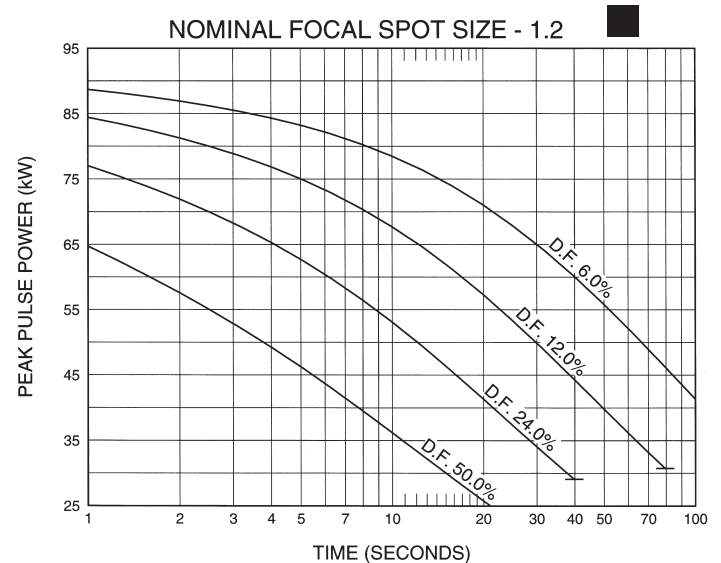
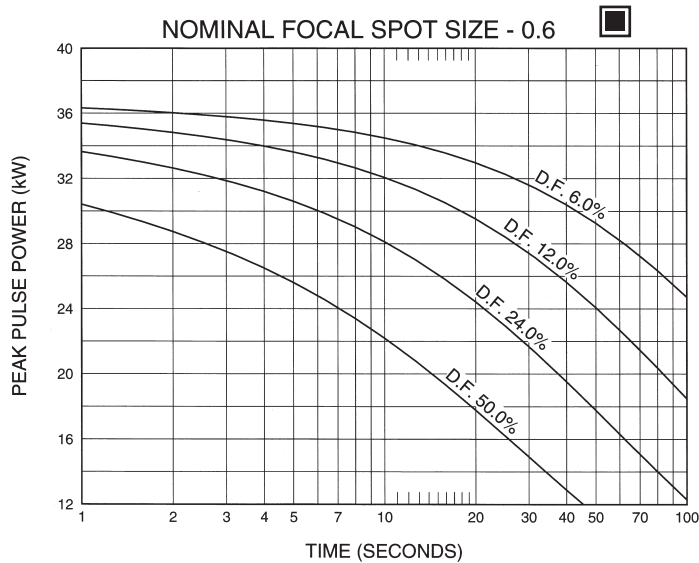

Nominal anode input power for the anode heat content 70%. IEC 60613

Puissance calorifique nominale de l'anode: 70%, CEI 60613

Thermische Anodenbezugsleistung bei einer Wärmespeicherung von 70%. IEC 60613

Aproximadamente el poder de penetración para obtener un almacenaje de calor del anodo de 70%. IEC 60613

## SERIAL LOAD RATINGS

### HOW TO USE SERIAL LOAD RATING CHARTS

**General:** Serial Radiography puts a severe demand on the x-ray tube due to the large number of exposures made in rapid succession. Intervals between exposures are fixed and so short that it is not possible for the anode track to cool to any extent during the exposure series. Therefore, the temperature of the anode track increases from exposure to exposure. The kW values used in the angiographic charts have been determined to prevent damage to the anode. The angiographic rating charts are usable to 100% anode heat storage. Exceeding 100% anode heat storage will cause anode track erosion with high risk of tube destruction.

**Definition of Terms**

**Number of Exposures in Series:** The number of exposures made in succession or the number of exposures made during one contrast injection.

**Exposure Rate:** The number of exposures made per second. For a series of exposures where the exposure rate changes, it must be assumed that all exposures will be made at the maximum rate. For example, if during a series 10 exposures will occur at one per second and 30 exposures at 4 per second, use the kW ratings in the 40 exposure column at 4 per second rate.

**Exposure Time:** Time in seconds of each exposure.

**USING THE CHARTS:**

**Select Correct Chart:**

50/60 or 150/180 Hz  
0.6 or 1.2 Focal Spot

Note: 150/180 Hz rotor speed recommended for all angiography.

**Determine the number of exposures in Series:** With cut film angiography the number of exposures are known, however in Digital Angiography the number of exposures commonly are not known. When determining the number of exposures, assume worst case or past history.

**Note:** Most angiographic x-ray tubes fail from underestimating the number of exposures made in a series.

**Determine kW of each exposure in Series:** Referring to chart —find block under “Number of Exposures in Series” that is greater than or equal to expected number of exposures in Series. On left side directly opposite this block under “Exposure Rate per Second” column, select maximum rate per second that will be used for the exposure series. At the intersection of exposure rate and exposure time in seconds, find maximum kW allowed for each exposure.

**kW = pkV x mA:** The kW of the exposure can be any combination of mA and pkV allowed by the Radiographic and Filament Emission charts.

For Example: 80 pkV and 500 mA = 40 kW

**Example:** From chart A-192 150/180 Hz 3 Phase 1.2 Focal Spot, determine kW allowed with following known factors.  
Maximum number of exposures .....40  
Exposure time .050 second (50 milliseconds)  
Maximum Exposure per second .....4

From chart find 40 exposure block. On left side directly opposite this block under “Exposure Rate per Second” column, select 4 exposures per second. Find .050 seconds at top of chart. At intersection of exposure rate line and exposure time, find 56.2 kW.



Serial Load Ratings IEC 60613  
 Abaques de charges successives CEI 60613  
 Serienbetrieb-Belastungskurven IEC 60613  
 Ratio de carga en serie IEC 60613

0.6 Focal Spot 3Ø 12 Degrees 150/180 Hz  
 0.6 Dimension Focale 3Ø 12 Degrés 150/180 Hz  
 0.6 Brennfleck 3Ø 12 Grad 150/180 Hz  
 0.6 De Marcas Focales 3Ø 12 Grados 150/180 Hz

EXPOSURE RATE PER SECOND	TUBE LOAD (kW) AS A FUNCTION OF THE EXPOSURE TIME (SEC.) OF THE INDIVIDUAL RADIOGRAPHS OF THE SERIES															NUMBER OF EXPOSURES IN SERIES
	.010	.020	.030	.040	.050	.060	.080	.100	.120	.140	.160	.180	.200	.225	.250	
1	35.6	34.2	33.1	32.1	31.3	30.5	29.1	27.9	26.9	26.0	25.1	24.3	23.6	22.8	22.1	20
2	35.5	34.0	32.8	31.8	30.9	30.1	28.6	27.3	26.2	25.2	24.3	23.5	22.8	21.9	21.2	
3	35.4	33.8	32.6	31.5	30.5	29.6	28.1	26.7	25.6	24.5	23.6	22.8	22.0	21.1	20.3	
4	35.3	33.6	32.3	31.2	30.2	29.2	27.6	26.2	25.0	23.9	22.9	22.1	21.3	20.3	.0	
8	34.9	32.9	31.3	30.0	28.8	27.7	25.8	24.2	22.8	.0	.0	.0	.0	.0	.0	
15	34.3	31.9	29.8	28.1	26.7	25.4	.0	.0	.0	.0	.0	.0	.0	.0	.0	
30	33.3	30.2	27.7	.0	.0	.0	.0	.0	.0	.0	.0	.0	.0	.0	.0	
1	35.1	33.2	31.7	30.4	29.3	28.3	26.5	24.9	23.6	22.4	21.4	20.5	19.6	18.7	17.8	40
2	34.9	33.0	31.4	30.1	28.9	27.8	25.9	24.4	23.0	21.8	20.7	19.8	18.9	18.0	17.1	
3	34.8	32.8	31.2	29.7	28.5	27.4	25.5	23.8	22.4	21.2	20.1	19.1	18.3	17.3	16.5	
4	34.7	32.6	30.9	29.4	28.1	27.0	25.0	23.3	21.8	20.6	19.5	18.5	17.7	16.7	.0	
8	34.3	31.8	29.8	28.2	26.7	25.4	23.2	21.4	19.9	.0	.0	.0	.0	.0	.0	
15	33.6	30.7	28.2	26.2	24.5	23.1	.0	.0	.0	.0	.0	.0	.0	.0	.0	
30	32.4	28.7	25.8	.0	.0	.0	.0	.0	.0	.0	.0	.0	.0	.0	.0	
1	34.5	32.3	30.5	28.9	27.6	26.4	24.3	22.5	21.1	19.8	18.7	17.7	16.8	15.9	15.0	60
2	34.4	32.1	30.2	28.6	27.2	25.9	23.8	22.0	20.5	19.2	18.1	17.1	16.3	15.3	14.4	
3	34.3	31.9	29.9	28.3	26.8	25.5	23.3	21.5	20.0	18.7	17.6	16.6	15.7	14.8	13.9	
4	34.2	31.7	29.6	27.9	26.4	25.1	22.9	21.1	19.5	18.2	17.1	16.1	15.2	14.3	.0	
8	33.7	30.8	28.6	26.7	25.1	23.7	21.3	19.4	17.8	.0	.0	.0	.0	.0	.0	
15	33.0	29.7	26.9	24.8	23.0	21.5	.0	.0	.0	.0	.0	.0	.0	.0	.0	
30	31.7	27.6	24.5	.0	.0	.0	.0	.0	.0	.0	.0	.0	.0	.0	.0	
1	34.0	31.4	29.3	27.6	26.1	24.7	22.4	20.6	19.0	17.7	16.6	15.6	14.7	13.8	12.9	80
2	33.9	31.2	29.1	27.3	25.7	24.3	22.0	20.1	18.6	17.2	16.1	15.1	14.3	13.3	12.5	
3	33.8	31.0	28.8	26.9	25.3	23.9	21.6	19.7	18.1	16.8	15.7	14.7	13.8	12.9	12.1	
4	33.7	30.8	28.5	26.6	25.0	23.6	21.2	19.3	17.7	16.4	15.3	14.3	13.4	12.5	.0	
8	33.2	30.0	27.5	25.4	23.7	22.2	19.7	17.8	16.2	.0	.0	.0	.0	.0	.0	
15	32.4	28.8	25.9	23.6	21.7	20.1	.0	.0	.0	.0	.0	.0	.0	.0	.0	
30	31.1	26.7	23.5	.0	.0	.0	.0	.0	.0	.0	.0	.0	.0	.0	.0	
1	33.6	30.6	28.3	26.4	24.7	23.3	20.9	18.9	17.4	16.0	14.9	13.9	13.1	12.2	11.4	100
2	33.4	30.4	28.0	26.0	24.4	22.9	20.5	18.5	17.0	15.6	14.5	13.6	12.7	11.8	11.0	
3	33.3	30.2	27.8	25.7	24.0	22.5	20.1	18.1	16.6	15.3	14.1	13.2	12.4	11.5	10.7	
4	33.2	30.0	27.5	25.4	23.7	22.2	19.7	17.8	16.2	14.9	13.8	12.8	12.0	11.1	.0	
8	32.7	29.2	26.5	24.3	22.5	20.9	18.4	16.4	14.9	.0	.0	.0	.0	.0	.0	
15	31.9	28.0	24.9	22.6	20.6	19.0	.0	.0	.0	.0	.0	.0	.0	.0	.0	
30	30.6	26.0	22.6	.0	.0	.0	.0	.0	.0	.0	.0	.0	.0	.0	.0	
1	32.4	28.8	26.0	23.7	21.9	20.3	17.7	15.8	14.2	13.0	11.9	11.0	10.0	8.9	8.0	150
2	32.3	28.6	25.7	23.5	21.6	20.0	17.4	15.5	13.9	12.7	11.7	10.8	10.0	8.9	8.0	
3	32.2	28.4	25.5	23.2	21.3	19.7	17.1	15.2	13.7	12.4	11.4	10.5	9.8	8.9	8.0	
4	32.0	28.2	25.3	22.9	21.0	19.4	16.9	14.9	13.4	12.2	11.1	10.3	9.5	8.8	.0	
8	31.5	27.4	24.3	21.9	20.0	18.4	15.8	13.9	12.4	.0	.0	.0	.0	.0	.0	
15	30.8	26.3	22.9	20.4	18.4	16.8	.0	.0	.0	.0	.0	.0	.0	.0	.0	
30	29.4	24.3	20.7	.0	.0	.0	.0	.0	.0	.0	.0	.0	.0	.0	.0	
1	29.4	24.4	20.9	18.3	16.3	14.7	12.3	10.0	8.3	7.1	6.3	5.6	5.0	4.4	4.0	300
2	29.3	24.2	20.7	18.1	16.1	14.5	12.1	10.0	8.3	7.1	6.3	5.6	5.0	4.4	4.0	
3	29.2	24.0	20.5	17.9	15.9	14.3	12.0	10.0	8.3	7.1	6.3	5.6	5.0	4.4	4.0	
4	29.1	23.9	20.3	17.7	15.7	14.2	11.8	10.0	8.3	7.1	6.3	5.6	5.0	4.4	.0	
8	28.6	23.3	19.7	17.1	15.1	13.5	11.2	9.6	8.3	.0	.0	.0	.0	.0	.0	
15	27.9	22.3	18.6	16.0	14.1	12.5	.0	.0	.0	.0	.0	.0	.0	.0	.0	
30	26.6	20.7	17.0	.0	.0	.0	.0	.0	.0	.0	.0	.0	.0	.0	.0	

**Note:**  
 1. (kW) of Exposure Equals mA x kV. For Example: 70 kV x 300 mA = 21 kW.  
 2. Exposures less than .010 seconds will have a kW rating same as .010 seconds.

**Remarque:**  
 1. (kW) en exposition égale kV x mA. Par exemple: 70 kV x 300 mA = 21 kW.  
 2. Les expositions inférieures à 0.010 sec. ont les mêmes valeurs en kW que celles de 0.010 sec.

**Anmerkungen:**  
 1. (kW) der Belichtung ist gleich mA x kV. Zum Beispiel: 70 kV x 300 mA = 21 kW.  
 2. Belichtungen von weniger als .010 Sekunden haben die gleichen kW Werte wie die von .010 Sekunden.

**Nota:**  
 1. (kW) De exposición se calcula multiplicando mA x kV-por ejemplo: 70 kV x 300 mA = 21 kW.  
 2. Para exposición de menos de .010 segundos, el resultado en (kW) sería lo mismo que el de .010 segundos.

Nominal anode input power for the anode heat content 70%. IEC 60613

Puissance calorifique nominale de l'anode: 70%, CEI 60613

Thermische Anodenbezugsleistung bei einer Wärmespeicherung von 70%. IEC 60613

Aproximadamente el poder de penetracion para obtener un almacenaje de calor del anodo de 70%. IEC 60613

Serial Load Ratings IEC 60613  
 Abaques de charges successives CEI 60613  
 Serienbetrieb-Belastungskurven IEC 60613  
 Ratio de carga en serie IEC 60613

1.2 Focal Spot 3Ø 12 Degrees 150/180 Hz  
 1,2 Dimension Focale 3Ø 12 Degrés 150/180 Hz  
 1.2 Brennfleck 3Ø 12 Grad 150/180 Hz  
 1.2 De Marcas Focales 3Ø 12 Grados 150/180 Hz

EXPOSURE RATE PER SECOND	TUBE LOAD (kW) AS A FUNCTION OF THE EXPOSURE TIME (SEC.) OF THE INDIVIDUAL RADIOGRAPHS OF THE SERIES															NUMBER OF EXPOSURES IN SERIES
	.010	.020	.030	.040	.050	.060	.080	.100	.120	.140	.160	.180	.200	.225	.250	
1	88.5	82.3	77.5	73.4	69.9	66.8	61.5	57.2	53.4	50.2	47.4	44.9	42.6	40.2	38.0	20
2	87.9	81.2	76.1	71.8	68.0	64.8	59.2	54.7	50.8	47.5	44.7	42.2	39.9	37.5	35.3	
3	87.3	80.2	74.7	70.2	66.3	62.8	57.1	52.4	48.5	45.2	42.3	39.8	37.6	35.1	33.0	
4	86.8	79.4	73.7	69.0	65.0	61.5	55.1	50.3	46.4	43.0	40.1	37.6	35.5	33.1	.0	
8	85.0	76.5	70.0	64.7	60.3	56.5	50.0	45.0	41.0	.0	.0	.0	.0	.0	.0	
15	82.6	72.7	65.3	59.4	54.6	50.4	.0	.0	.0	.0	.0	.0	.0	.0	.0	
30	79.0	67.2	58.8	.0	.0	.0	.0	.0	.0	.0	.0	.0	.0	.0	.0	
1	85.2	76.8	70.4	65.2	60.8	57.0	50.8	45.8	41.8	38.5	35.7	33.3	31.2	28.9	26.9	40
2	84.5	75.7	69.0	63.6	59.1	55.2	48.9	43.9	39.9	36.6	33.9	31.5	29.4	27.2	25.3	
3	83.9	74.6	67.7	62.1	57.5	53.5	47.1	42.2	38.2	34.9	32.2	29.9	27.9	25.7	23.9	
4	83.4	73.8	66.7	61.0	56.2	52.3	45.5	40.6	36.6	33.4	30.7	28.4	26.5	24.4	.0	
8	81.3	70.7	62.9	56.8	51.9	47.8	41.1	36.2	32.4	.0	.0	.0	.0	.0	.0	
15	78.4	66.4	58.0	51.5	46.4	42.2	.0	.0	.0	.0	.0	.0	.0	.0	.0	
30	73.9	60.2	51.0	.0	.0	.0	.0	.0	.0	.0	.0	.0	.0	.0	.0	
1	82.2	72.1	64.6	58.7	53.8	49.7	43.3	38.4	34.5	31.3	28.7	26.5	24.6	22.2	20.0	60
2	81.6	71.0	63.3	57.3	52.3	48.2	41.8	36.9	33.1	30.0	27.4	25.3	23.4	21.5	19.9	
3	80.9	70.0	62.1	55.9	51.0	46.8	40.4	35.5	31.8	28.7	26.2	24.1	22.4	20.5	18.9	
4	80.3	69.2	61.1	54.9	49.9	45.8	39.1	34.3	30.6	27.6	25.1	23.1	21.4	19.5	.0	
8	78.2	66.1	57.6	51.1	46.0	41.9	35.4	30.8	27.3	.0	.0	.0	.0	.0	.0	
15	75.2	61.9	52.9	46.3	41.2	37.0	.0	.0	.0	.0	.0	.0	.0	.0	.0	
30	70.3	55.6	46.2	.0	.0	.0	.0	.0	.0	.0	.0	.0	.0	.0	.0	
1	79.5	68.0	59.7	53.4	48.3	44.2	37.7	33.0	29.3	26.4	23.4	20.8	18.8	20.8	15.0	80
2	78.8	67.0	58.6	52.1	47.1	42.9	36.5	31.9	28.2	25.4	23.1	20.8	18.8	20.8	15.0	
3	78.1	66.0	57.4	51.0	45.9	41.7	35.4	30.8	27.2	24.4	22.2	20.3	18.7	20.3	15.0	
4	77.6	65.2	56.6	50.1	44.9	40.8	34.3	29.8	26.3	23.6	21.3	19.5	18.0	19.5	.0	
8	75.5	62.3	53.3	46.7	41.6	37.5	31.3	26.9	23.6	.0	.0	.0	.0	.0	.0	
15	72.4	58.2	48.9	42.3	37.3	33.3	.0	.0	.0	.0	.0	.0	.0	.0	.0	
30	67.5	52.1	42.6	.0	.0	.0	.0	.0	.0	.0	.0	.0	.0	.0	.0	
1	76.9	64.3	55.5	49.0	43.8	39.7	33.5	29.0	25.0	21.4	18.8	16.7	15.0	13.3	12.0	100
2	76.2	63.3	54.5	47.9	42.8	38.7	32.5	28.0	24.7	21.4	18.8	16.7	15.0	13.3	12.0	
3	75.6	62.4	53.5	46.9	41.7	37.7	31.6	27.2	23.9	21.3	18.8	16.7	15.0	13.3	12.0	
4	75.0	61.7	52.7	46.0	40.9	36.9	30.7	26.4	23.1	20.6	18.6	16.7	15.0	13.3	.0	
8	73.0	58.9	49.7	43.0	38.0	34.0	28.1	24.0	20.9	.0	.0	.0	.0	.0	.0	
15	69.9	55.1	45.7	39.1	34.1	30.3	.0	.0	.0	.0	.0	.0	.0	.0	.0	
30	65.0	49.2	39.7	.0	.0	.0	.0	.0	.0	.0	.0	.0	.0	.0	.0	
1	71.2	56.6	47.2	40.6	35.6	31.8	25.0	20.0	16.7	14.3	12.5	11.1	10.0	8.9	8.0	150
2	70.5	55.8	46.4	39.8	34.9	31.0	25.0	20.0	16.7	14.3	12.5	11.1	10.0	8.9	8.0	
3	69.9	55.1	45.7	39.0	34.1	30.3	24.9	20.0	16.7	14.3	12.5	11.1	10.0	8.9	8.0	
4	69.4	54.5	45.0	38.4	33.5	29.8	24.3	20.0	16.7	14.3	12.5	11.1	10.0	8.9	.0	
8	67.5	52.1	42.6	36.1	31.4	27.7	22.5	18.9	16.4	.0	.0	.0	.0	.0	.0	
15	64.6	48.8	39.3	33.0	28.4	25.0	.0	.0	.0	.0	.0	.0	.0	.0	.0	
30	59.9	43.6	34.4	.0	.0	.0	.0	.0	.0	.0	.0	.0	.0	.0	.0	
1	58.2	41.8	32.7	25.0	20.0	16.7	12.5	10.0	8.3	7.1	6.3	5.6	5.0	4.4	4.0	300
2	57.7	41.3	32.3	25.0	20.0	16.7	12.5	10.0	8.3	7.1	6.3	5.6	5.0	4.4	4.0	
3	57.2	40.8	31.8	25.0	20.0	16.7	12.5	10.0	8.3	7.1	6.3	5.6	5.0	4.4	4.0	
4	56.9	40.4	31.5	25.0	20.0	16.7	12.5	10.0	8.3	7.1	6.3	5.6	5.0	4.4	4.0	
8	55.4	38.9	30.1	24.6	20.0	16.7	12.5	10.0	8.3	.0	.0	.0	.0	.0	.0	
15	53.1	36.8	28.2	22.9	19.3	16.6	.0	.0	.0	.0	.0	.0	.0	.0	.0	
30	49.4	33.2	25.1	.0	.0	.0	.0	.0	.0	.0	.0	.0	.0	.0	.0	

**Note:**  
 1. (kW) of Exposure Equals mA x kV. For Example: 70 kV x 300 mA = 21 kW.  
 2. Exposures less than .010 seconds will have a kW rating same as .010 seconds.

**Remarque:**  
 1. (kW) en exposition égale kV x mA. Par exemple: 70 kV x 300 mA = 21 kW.  
 2. Les expositions inférieures à 0.010 sec. ent les mêmes valeurs en kW que celles de 0.010 sec.

**Anmerkungen:**  
 1. (kW) der Belichtung is gleich mA x kV Zum Beispiel: 70 kV x 300 mA = 21 kW.  
 2. Belichtungen von weniger als .010 Sekunden haben die gleichen kW Werte wie die von .010 Sekunden.

**Nota:**  
 1. (kW) De exposición se calcula multiplicando mA x kV-por ejemplo: 70 kV x 300 mA = 21 kW.  
 2. Para exposición de menos de .010 segundos, el resultado en (kW) seria lo mismo que el de .010 segundos.

Nominal anode input power for the anode heat content 70%. IEC 60613

Puissance calorifique nominale de l'anode: 70%, CEI 60613

Thermische Anodenbezugsleistung bei einer Wärmespeicherung von 70%. IEC 60613

Aproximadamente el poder de penetracion para obtener un almacenaje de calor del anodo de 70%. IEC 60613

3 Ø Full Wave

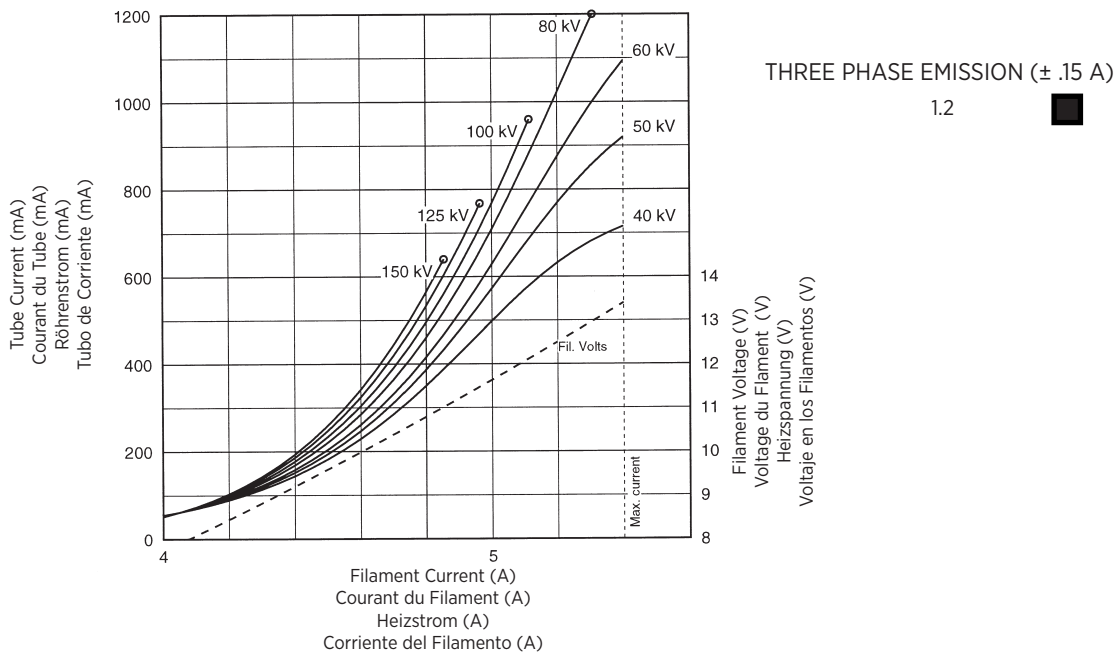
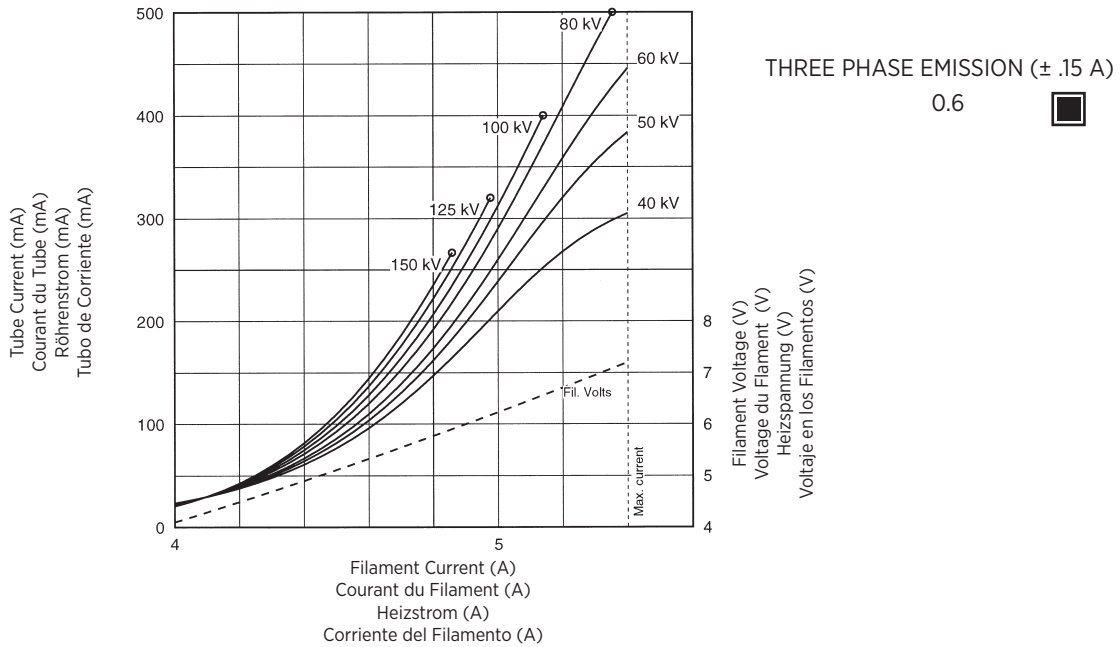

Note:  
 When using these emission curves for trial exposures, refer to the power rating curves shown for maximum kV, tube emission, filament current, exposure time, and target speed.

Remarque:  
 Lors de l'utilisation de ces abaques pour des expositions d'essai, référez-vous aux courbes maximales de kV, d'émission du filament, de temps d'exposition et de vitesse de rotation.

Anmerkung:  
 Wenn Sie diese Emissionskurven für Testaufnahmen verwenden, beziehen Sie sich hierbei auf die entsprechenden Nennleistungskurven für max. kV-Werte, Röhrenemission, Heizstrom, und Anodendrehzahl.

Nota:  
 Si utiliza estas curvas de emisión para exposiciones de prueba, refiérase a las curvas de gradación de potencia para el máximo de kV, tubo de emisión, corriente en los filamentos, tiempo de exposición, y a las curvas de velocidad del objetivo.

